

### Features

- Single-speed whirlpool offers performance and value with 8 fully adjustable jets.
- Hydromassage flow and direction can be controlled at each jet.
- Built-in heater.
- Comfort Depth® design offers a convenient 19" step-over height while retaining the same depth as a standard 21" bath.
- Integral lumbar support.
- Slotted overflow allows for deep soaking.
- Textured bottom surface.
- Coordinates with other products in the Archer collection.

### Material

- Acrylic.

### Hydrotherapy

- Whirlpool.

### Installation

- Reversible drain.
- Drop-in.

### Required Products/Accessories

K-7271 Brass Slotted Overflow Bath Drain

or

K-7272 PVC Slotted Overflow Bath Drain

### Recommended Products/Accessories

K-24916 Wireless Music Kit

K-23726 Drain treatment

K-23732 Tub & shower cleaner



ADA

### Codes/Standards

ASME A112.19.7/CSA B45.10

CSA B45.5/IAPMO Z124

UL 1795

CSA C22.2 No. 218.2

ADA









ICC/ANSI A117.1

### KOHLER® Plastic Baths and Receptors Lifetime Limited Warranty KOHLER® Hydrotherapy Components Five-Year Limited Warranty

See website for detailed warranty information.

### Available Colors/Finishes

*Color tiles intended for reference only.*

Color	Code	Description
	0	White
	96	Biscuit
	NY	Dune
	95	Ice™ Grey
	G9	Sandbar
	33	Mexican Sand™
	K4	Cashmere
	58	Thunder™ Grey
	7	Black Black™

No change in measurements if connected with drain illustrated. (K-7272)

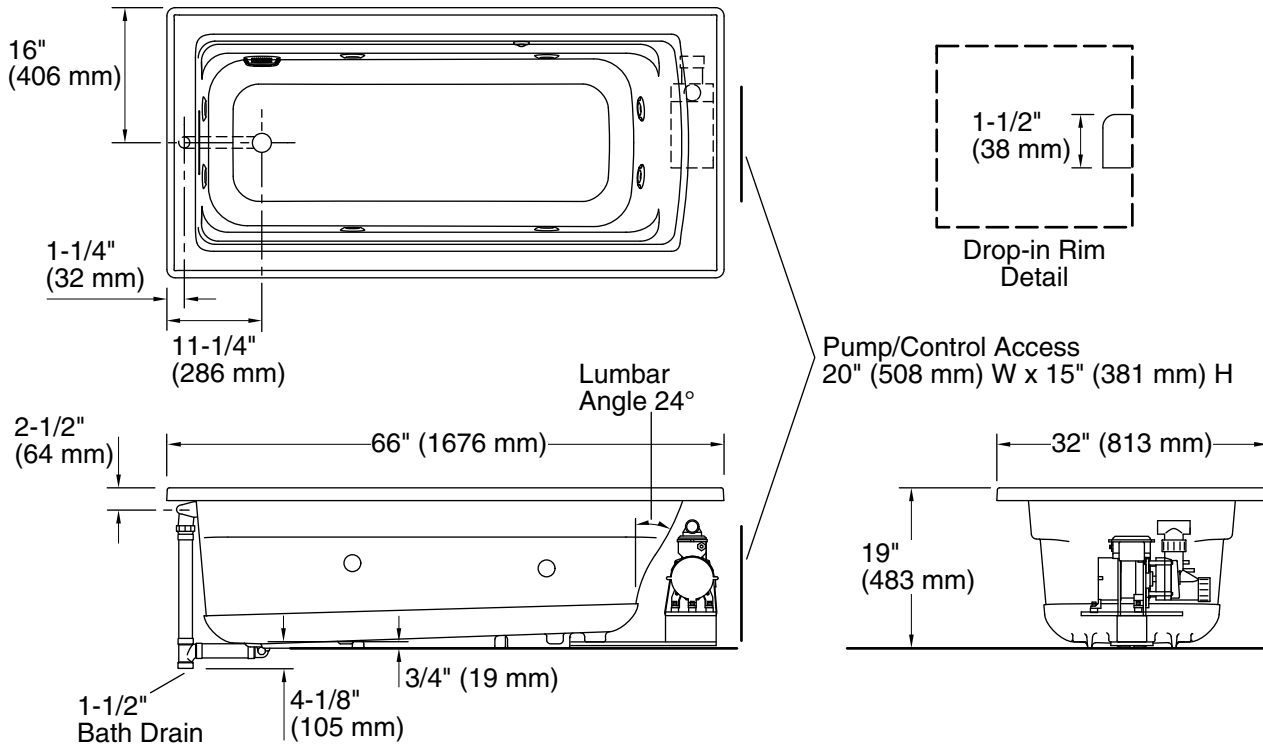

### Required Electrical Service

Two dedicated circuits required, protected with Class A Ground-Fault Circuit-Interrupter (GFCI). Outside North America, this device may be known as a Residual Current Device (RCD).

Pump: 120 V, 15 A, 60 Hz  
Heater: 120 V, 15 A, 60 Hz

### Technical Information

All product dimensions are nominal.

Installation: Drop-in  
Drain location: Reversible  
Basin area, bottom: 50-3/8" x 19-5/8" (1280 mm x 498 mm)  
Basin area, top: 57-5/16" x 24-1/16" (1456 mm x 611 mm)  
Weight: 106 lbs (48.1 kg)  
Minimum floor load: 47 lbs/ft<sup>2</sup> (229.5 kg/m<sup>2</sup>)  
Water depth: 15-5/16" (389 mm)  
Water capacity: 33 gal (124.9 L)  
Cutout: Drop-in, 64-1/2" x 30-1/2" (1638 mm x 775 mm) with ( ) radius corners  
Electrical component rating: Pump: 120 V, 7.0 A, 60 Hz  
Heater: 120 V, 12.5 A, 60 Hz, 1500 W

### Notes

Measure your actual product for rough-in details.

Install this product according to the installation instructions.

The hot water supply should be 70% of the capacity of the bath or greater. Installations will vary.

This product is designed for drop-in installation only. It is not suited for use in a three-wall alcove with an overhead shower.

ADA compliant when installed to the specific requirements of these regulations.